

# On the Feasibility of Precoded Single User MIMO for LTE-A Uplink

Gilberto Berardinelli #, Luis Ángel Maestro Ruiz de Temiño #, Simone Frattasi #, Troels B.Sørensen #, Preben Mogensen #, Kari Pajukoski \*

# Department of Electronic Systems, Aalborg University, Denmark

Email: {gb, lam, sf, tbs, pm}@es.aau.dk

\* Nokia-Siemens Networks, Oulu, Finland

Email: kari.pajukoski@nsn.com

**Abstract**—The 3rd Generation Partnership Project (3GPP) is currently specifying the system requirements for Long Term Evolution - Advanced (LTE-A), having as a target peak data rates of 1 Gbit/s in local areas and 100 Mbit/s in wide areas. To meet these ambitious requirements for the uplink, multiple-input-multiple-output (MIMO) antenna techniques are expected to be deployed. In this paper, several channel-aware MIMO precoding techniques are presented. Specifically, precoded single user spatial multiplexing for both Orthogonal Frequency Division Multiplexing (OFDM) and Single Carrier Frequency Division Multiplexing (SC-FDM) is studied, and its feasibility in a LTE-A uplink system is discussed. Particular emphasis is given to the limited feedback precoding, where a codebook generation method based on the Lloyd algorithm is proposed. Results show that, when full channel knowledge is available at both the transmitter and the receiver, precoding leads to a spectral efficiency gain up to 4 dB over open loop transmission; furthermore, OFDM slightly outperforms SC-FDM because of its higher robustness to the noise. Limited feedback precoding has been shown to be effective and consistently robust to the subcarrier grouping in a urban micro scenario. However, the performance is severely degraded in the *blind* precoding case, where transmitter and receiver compute the precoding matrix independently, due to the high sensitivity to the delay. Finally, the precoding operation over the SC-FDM signal is shown to increase its Peak to Average Power Ratio (PAPR), thus reducing its advantage with respect to OFDM.

**Index Terms**—LTE-A, MIMO, OFDMA, PAPR, SC-FDMA, precoding, spatial multiplexing, transmit diversity

## I. INTRODUCTION

The 3rd Generation Partnership Project (3GPP) is currently involved in the definition of the minimum system requirements for Long Term Evolution - Advanced (LTE-A) systems. The aim of LTE-A is to enhance the previous Release 8 [1] to meet ambitious target data rates as 1 Gbit/s in local areas and 100 Mbit/s in wide areas. To cope with these requirements, very high spectrum allocation of 100 MHz and more as well as multiple antenna techniques, promising a linear increase of the capacity of the wireless links, are expected to be deployed. In the

Release 8, Orthogonal Frequency Division Multiplexing (OFDM) has been selected for the downlink due to its high robustness to the multipath as well as its flexibility in the resources allocation [2], and Single Carrier Frequency Division Multiplexing (SC-FDM) for the uplink, given its advantageous low Peak to Average Power Ratio (PAPR) property. SC-FDM suffers from an effect called "noise enhancement" [3], which degrades its performance when linear receivers are used. It can however be compensated by using iterative detection techniques based on turbo equalization [4]. Nevertheless, the final choice on the most appropriate access scheme for LTE-A uplink has not been made yet, since there are several benefits in having the same scheme on both uplink and downlink [5].

Besides the selection of the uplink modulation scheme, a current open task for the 3GPP is the evaluation of uplink Single User Multiple-Input-Multiple-Output (SU MIMO) schemes. While in the previous Release 8 only single transmit antenna schemes have been standardized for the uplink, SU MIMO is, in fact, expected to be included in LTE-A to cope with the high data rates requirements. In most of the transceiver applications, knowledge of the channel state on which transmission is performed is generally assumed at the receiver, possibly with a certain error due to the non-ideality of the channel estimation. It is well known that, in MIMO schemes, performance can be further leveraged when some degree of channel knowledge is also available at the transmitter, through a precoding operation of the data streams [6].

In this paper, several precoding techniques are evaluated for LTE-A, considering Spatial Multiplexing (SM) transmission. Channel-aware precoding has been widely treated in literature. In [7], Sampath et al. focused on the derivation of optimal precoders for a number of criteria (i.e., maximum information rate, equal error design, etc.), assuming full knowledge of the channel state at the transmitter. Similar results have been obtained by Scaglione et al. in [8]. Others, like [9] and [10], faced the problem of defining a codebook of precoding matrices to be selected using criteria related to the state of the channel, whenever only partial knowledge of the channel can be made available at the transmitter. In such schemes,

Manuscript received September 1, 2008; revised January 1, 2009; accepted January 21, 2009.

the receiver feeds back the index of the selected matrix to the transmitter, which performs the precoding in the following transmissions.

Even though the cited papers offer a deep understanding of the issue and valid analytical solutions, they are mostly referring to generic systems. Furthermore, non-ideality of the involved parameters is seldom discussed. As aforementioned, we instead refer to the specific case of LTE-A. The impact of real degradation factors like delay and subcarrier grouping is widely discussed. Particular emphasis is given to the limited feedback precoding, where a codebook design method based on the Lloyd Algorithm [11] and two criteria for the precoding matrix selection are proposed. A key point of our evaluation is the comparison between OFDM and SC-FDM, since the precoding operation affects them differently.

Our main goal is obtaining useful insights on the feasibility of precoding SU MIMO techniques for LTE-A systems, bearing in mind their potential inclusion in the uplink of the upcoming standard.

The paper is organized as follows. Section II introduces the LTE-A system model. In Section III, precoding for spatial multiplexing is presented, covering a number of solutions (unquantized and limited feedback, blind precoding). In Section V, performance is evaluated for LTE parameters. Finally, Section VI summarizes the conclusions and states the future work.

## II. SYSTEM MODEL

A simplified baseband MIMO OFDM/SC-FDM system with  $N_S$  data streams,  $N_T$  transmit antennas and  $N_R$  receive antennas is depicted in Fig.1. On the transmitter side, the bits of the  $N_S$  data streams or codewords (CWs) are encoded, interleaved and mapped onto QPSK or M-QAM symbols, yielding the vectors  $\mathbf{d}_s$ ,  $s = 1, \dots, N_S$ . Then, a Discrete Fourier Transform (DFT) is performed in the case of SC-FDM, spreading each data symbol over all the subcarriers, obtaining the vectors  $\mathbf{s}_s$ ,  $s = 1, \dots, N_S$ . For OFDM, each symbol is mapped onto one subcarrier, i.e.,  $\mathbf{s}_s = \mathbf{d}_s$ . The complex symbols  $\mathbf{s}_s$  are fed to the CW-to-layer mapper, which rearranges them onto the  $N_T$  transmit antennas depending on the selected scheme, and afterwards to the precoder block. The output of the precoder for each subcarrier  $k$  can be expressed as:

$$\mathbf{q}[k] = \mathbf{F}[k]\mathbf{x}[k] \quad (1)$$

where  $\mathbf{x}[k] = [x_1(k), x_2(k), \dots, x_{N_T}(k)]^T$  is a vector containing the encoded MIMO complex transmit symbols at subcarrier  $k$  from the  $N_T$  transmit antennas, and  $\mathbf{F}[k]$  is a  $N_T \times N_T$  complex precoding matrix. Next, pilot symbols are inserted in predefined subcarrier positions at each transmit antenna in order to enable channel estimation at the receiver. Finally, an Inverse Fast Fourier Transform (IFFT) is applied and a Cyclic Prefix (CP) is appended [2].

Assuming that the channel is static over the duration of an OFDM symbol and that the CP is long enough to

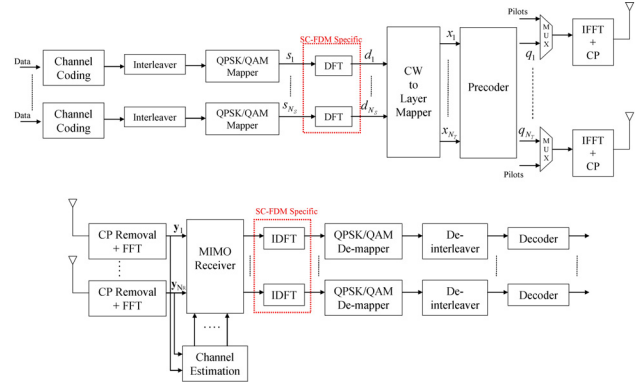

Fig. 1. Simplified OFDM/SC-FDM block diagram

cope with the maximum delay of the multipath channel, the received signal at time  $t_{\alpha_0}$  after CP removal and Fast Fourier Transform (FFT) can be expressed as:

$$\mathbf{y}_{t_{\alpha_0}}[k] = \mathbf{H}_{t_{\alpha_0}}[k]\mathbf{q}[k] + \mathbf{w}[k] \quad (2)$$

where  $\mathbf{w}[k] = [w_1(k), w_2(k), \dots, w_{N_{TR}}(k)]^T$  is the additive white Gaussian noise vector with autocorrelation matrix given by  $\mathbf{R}_{\mathbf{w}\mathbf{w}} = E[\mathbf{w}[k]\mathbf{w}[k]^H] = \sigma_w^2 I_{N_{TR}}$ , where  $E[\cdot]$  and  $(\cdot)^H$  represent the expected value and the hermitian transpose operator respectively,  $I_{N_{TR}}$  denotes the  $N_{TR} \times N_{TR}$  identity matrix, and

$$\mathbf{H}_{t_{\alpha_0}}[k] = \begin{bmatrix} h_{11,t_{\alpha_0}}(k) & \dots & h_{1N_T,t_{\alpha_0}}(k) \\ \vdots & \ddots & \vdots \\ h_{N_R1,t_{\alpha_0}}(k) & \dots & h_{N_R N_T,t_{\alpha_0}}(k) \end{bmatrix} \quad (3)$$

is the channel transfer function matrix at subcarrier  $k$  at time  $t_{\alpha_0}$ , where  $h_{ij,t_{\alpha_0}}(k)$  denotes the complex channel gain from the transmit antenna  $j$  to the receive antenna  $i$ . The signal  $\mathbf{y}_{t_{\alpha_0}}$  is fed to the MIMO receiver block, which performs equalization of the received symbols to compensate the amplitude and phase distortions introduced by the channel. To do so, an estimate of the channel transfer function is provided by the channel estimation block. The rest of the receiver chain performs the reverse operations of the transmitter side (i.e., demapping, deinterleaving and decoding). Note that the Inverse Discrete Fourier Transform (IDFT) is responsible of the noise enhancement in SC-FDM systems, since the noise contribution on each subcarrier is spread over all symbols.

## III. PRECODING FOR SPATIAL MULTIPLEXING

In SM, the data streams are transmitted in parallel onto the different antennas (i.e.  $\mathbf{x}_s = \mathbf{d}_s$ ). This allows a significant increase of the spectral efficiency, when a Minimum Mean Square Error (MMSE) detector [12] is used at the receiver to reduce the interstream interference. SM is therefore a key feature to achieve the high data rates promised by LTE-A. Furthermore, it is expected that channel-aware precoding can further boost SM's performance. In this section, several precoding strategies for SM are presented, moving from the ideal solution to more feasible approaches, where different degrees of

channel knowledge are available at the transmitter through signaling. A blind precoding strategy, allowing to skip any feedback message, is also discussed.

### A. Ideal Precoding

Here, we assume to perfectly know the channel state at the transmitter. A common way to express the channel matrix at time instant  $t_{\alpha_0}$  in subcarrier  $k$  is through its Singular Value Decomposition (SVD) [13], as follows:

$$\mathbf{H}_{t_{\alpha_0}}[k] = \mathbf{U}_{t_{\alpha_0}}[k]\mathbf{\Sigma}_{t_{\alpha_0}}[k]\mathbf{V}_{t_{\alpha_0}}[k]^H \quad (4)$$

where  $\mathbf{\Sigma}_{t_{\alpha_0}}[k]$  is a  $N_R \times N_T$  matrix having in its diagonal the eigenvalues of  $\mathbf{H}_{t_{\alpha_0}}[k]^H\mathbf{H}_{t_{\alpha_0}}[k]$  (i.e.,  $\mathbf{\Sigma}_{t_{\alpha_0}}[k] = \text{diag}(\lambda_1, \dots, \lambda_K)$ , where  $K$  is the rank of  $\mathbf{H}_{t_{\alpha_0}}[k]$ ),  $\mathbf{U}_{t_{\alpha_0}}[k]$  is the  $N_R \times N_R$  matrix having as columns the eigenvectors of  $\mathbf{H}_{t_{\alpha_0}}[k]^H\mathbf{H}_{t_{\alpha_0}}[k]$ ,  $\mathbf{V}_{t_{\alpha_0}}[k]$  is the  $N_T \times N_T$  matrix having as columns the eigenvector of  $\mathbf{H}_{t_{\alpha_0}}[k]\mathbf{H}_{t_{\alpha_0}}[k]^H$ .  $\mathbf{U}_{t_{\alpha_0}}[k]$  and  $\mathbf{V}_{t_{\alpha_0}}[k]$  are unitary matrices (i.e.,  $\mathbf{U}_{t_{\alpha_0}}[k]\mathbf{U}_{t_{\alpha_0}}[k]^H = \mathbf{U}_{t_{\alpha_0}}[k]^H\mathbf{U}_{t_{\alpha_0}}[k] = \mathbf{I}_{N_R}$ , and  $\mathbf{V}_{t_{\alpha_0}}[k]\mathbf{V}_{t_{\alpha_0}}[k]^H = \mathbf{V}_{t_{\alpha_0}}[k]^H\mathbf{V}_{t_{\alpha_0}}[k] = \mathbf{I}_{N_T}$ ). Let us define now the following precoding matrix:

$$\mathbf{F}[k] = \mathbf{F}_{t_{\alpha_0}}[k] = \sqrt{\mathbf{R}_{\mathbf{xx}}}\bar{\mathbf{V}}_{t_{\alpha_0}}[k] \quad (5)$$

where  $\bar{\mathbf{V}}_{t_{\alpha_0}}[k]$  denotes the matrix containing the first  $K$  columns of  $\mathbf{V}_{t_{\alpha_0}}[k]$  and

$$\mathbf{R}_{\mathbf{xx}} = \text{diag}(P_1, \dots, P_{N_T}), \quad (6)$$

where  $P_1, \dots, P_{N_T}$  are the transmit powers on each antenna. A constraint on the total transmit power is assumed:

$$\sum_{i=1}^{N_T} P_i = P_O. \quad (7)$$

Without loss of generality, throughout this study we will assume  $K = N_T$ . It can be easily shown that, if the  $\mathbf{U}_{t_{\alpha_0}}[k]^H$  matrix is used as a matched filter at the receiver, the MIMO channel can be decomposed in  $N_T$  Single-Input-Single-Output (SISO) channels, even called eigenmodes, whose gains are given by  $\lambda_1^2, \dots, \lambda_{N_T}^2$ . This allows to increase the capacity of the MIMO system, since the interstream interference is *a priori* removed. Note that since  $\mathbf{V}_{t_{\alpha_0}}[k]$  is an unitary matrix, the constraint on the total transmit power is fulfilled.

1) *Power Allocation*: In traditional SM schemes, it is generally assumed that the transmit power is equally distributed among the antennas, i.e.,  $P_i = P_O/N_T$  with  $i = 1, \dots, N_T$ . However, when precoding is performed and therefore the MIMO channel can be decomposed in several SISO channels having different gains, additional performance improvements can be achieved by smartly assigning the power among the transmit antennas. Well-known waterfilling algorithms, based on assigning higher power to the stronger eigenmodes, seem not to be a good solution for LTE systems [14]. Here, we propose to properly weight the transmit power on each antenna depending on some critical parameter at the receiver, e.g., the joint uncoded Symbol Error Rate (SER).

For OFDM, when precoding is performed, the Signal-to-Noise-Ratio (SNR) of the  $i$ -th stream before the demodulation can be written as follows:

$$SNR_i = \frac{\bar{\lambda}_i^2 P_i}{\sigma_w^2} \quad (8)$$

where  $\bar{\lambda}_i^2$  is the average gain of the equivalent  $i$ -th SISO channel over all the subcarriers.

For SC-FDM, the SNR per stream must be computed after the IDFT, leading to the following expression [15]:

$$SNR_i = \frac{1}{\frac{1}{N_C} \sum_{j=1}^{N_C} \frac{\sigma_w^2}{\lambda_{i,j}^2 P_i + \sigma_w^2}} - 1, \quad (9)$$

where  $N_C$  is the number of subcarriers, and  $\lambda_{i,j}^2$  denotes the gain of the  $i$ -th eigenmode in subcarrier  $j$ . When equal power allocation is applied and the eigenmodes are ordered in a decreasing way, we always get

$$SNR_1 > SNR_2 > \dots > SNR_{N_T} \quad (10)$$

Since the previous SNRs can be easily mapped in analytical SER values, the vector of the transmit powers  $P_1, \dots, P_{N_T}$  can be chosen in order to minimize the average SER over all the streams, still keeping the total power constraint in Eq.(7). In [16], generic analytical expressions for the uncoded Bit Error Rate (*uncBER*) of rectangular symbol constellations in fading channels are provided. The SER can be easily approximated from these *uncBERs* as follows:

$$SER = 1 - (1 - \text{uncBER})^M \quad (11)$$

where  $M$  is the number of bits per symbol. The SER values can be stored in a look-up table, from which the transmitter performs an exhaustive search among the allowed  $P_i, i = 1, \dots, N_T$  combinations to find the one that minimizes the joint SER. It can be shown that this solution tends to enhance the transmit power on the weaker eigenmodes.

### B. Precoding with unquantized feedback

Unfortunately, the solution described in Subsection A cannot be applied in a real system. This is because the transmitter is not aware of the channel state at time instant  $t_{\alpha_0}$  on which it is going to send the data, and therefore it cannot compute  $\mathbf{F}_{t_{\alpha_0}}$ .

Nevertheless, the precoding matrix can be computed at the receiver by SVD of the estimated channel frequency response, and fed back to the transmitter, which uses it for the following transmission. Since our focus is on the uplink, we refer to the User Equipment (UE) as the transmitter and to the Base Station (BS) as the receiver. The procedure is explained in the following steps:

- At time instant  $t_{\alpha_0}$ , the BS estimates the channel frequency response  $\mathbf{H}_{t_{\alpha_0}}$  based on pilot information;
- the BS computes the precoding matrix  $\mathbf{F}_{t_{\alpha_0}}$  from  $\mathbf{H}_{t_{\alpha_0}}$  as in Eq.(5), and send it back to the UE;

- the UE precodes the data stream as in Eq.(1) by using  $\mathbf{F}_{t_{\alpha_0}}$ , and sends it to the channel at instant  $t_{\alpha_1} = t_{\alpha_0} + \Delta t$ .
- The BS estimates  $\mathbf{H}_{t_{\alpha_1}}$  from the received pilots and uses an MMSE detector to recover the data. The MMSE detector at subcarrier  $k$  can be written as follows:

$$\mathbf{Q}_{t_{\alpha_1}}[k] = (\mathbf{F}_{t_{\alpha_0}}[k]^H \mathbf{H}_{t_{\alpha_1}}[k]^H \mathbf{H}_{t_{\alpha_1}}[k] \mathbf{F}_{t_{\alpha_0}}[k] + \mathbf{R}_{ww} \mathbf{R}_{xx}^{-1})^{-1} \cdot \mathbf{F}_{t_{\alpha_0}}[k]^H \mathbf{H}_{t_{\alpha_1}}[k]^H \quad (12)$$

Therefore, both UE and BS agree on the precoding matrix, even though this is outdated with respect to the channel state on which transmission is performed. This approach could be considered close to the ideal solution if slow variation of the channel in the time interval  $\Delta t$  is assumed. In the next, we will refer to this scheme as precoding with *unquantized* feedback, since the precoding matrix obtained by SVD of  $\mathbf{H}$  is made available at the transmitter with infinite resolution.

### C. Precoding with limited feedback

In a real system, precoding with unquantized feedback is however unfeasible, since it leads to an infinite increase of the signaling overhead. As a valid trade-off between tolerable overhead and performance gain, several studies (i.e., [9], [10]) consider the definition of a limited size codebook of precoding matrices. The receiver must select the element of the codebook depending on some criterion, and feed back its index to the transmitter.

Here, a simple codebook generation method based on the well-known generalized Lloyd algorithm is proposed, as well as two different criteria for the selection of the element of the codebook. For simplicity, in the following we will consider a system with 2 transmit antennas.

Before describing the codebook generation process, let us elaborate on the SVD of the channel matrix. Many assumptions on the expression in Eq.(4) can be relaxed by exploiting the non-univocity of the SVD operation [13]. For instance, every column of  $\mathbf{V}_{t_{\alpha_0}}$  can be multiplied by an arbitrary phase element  $e^{j\phi}$ ,  $\phi \in [0, 2\pi]$ , as long as the corresponding column of  $\mathbf{U}_{t_{\alpha_0}}$  is multiplied by  $e^{-j\phi}$ . Therefore, it becomes possible writing  $\mathbf{V}_{t_{\alpha_0}}$  in the following form:

$$\mathbf{V}_{t_{\alpha_0}} = \mathbf{V}_{t_{\alpha_0}}(\theta, \varphi) = \begin{bmatrix} \cos\theta & \sin\theta \\ \sin\theta e^{j\varphi} & -\cos\theta e^{j\varphi} \end{bmatrix} \quad (13)$$

being Eq.(13) an expression that preserves the unitary property of the precoding matrix. Without loss of generality, we can assume  $\theta \in [0, \pi/2]$ ,  $\varphi \in [-\pi, \pi]$ .

Since our precoding matrix can be therefore expressed as a function of  $[\theta, \varphi]$ , the codebook design is reduced to a simple vector quantization problem. In other words, our goal is finding a set of  $[\hat{\theta}_z, \hat{\varphi}_z]$ ,  $z = 1, \dots, Z$  vectors that are representative of the whole space spanned by  $[\theta, \varphi]$ .

The Lloyd algorithm provides an elegant solution to the vector quantization problem. It is based on an iterative search of a codebook allowing to minimize a metric called *distorsion* with respect of a training set of vectors with random distribution [11]. The key point of the Lloyd Algorithm is the definition of a proper *distance* between the generic vector and their quantized form. In our case, we propose to use the angular distance, which can be defined as follows:

$$d(p, c_z) = 2 - \cos(\theta + \hat{\theta}_z) - \cos(\varphi + \hat{\varphi}_z), \quad (14)$$

where  $p = [\theta, \varphi]$  and  $c_z = [\hat{\theta}_z, \hat{\varphi}_z]$ . The steps of this algorithm applied to our scope can be summarized as follows:

- 1) Initialization: define the codebook  $\hat{C} = \{\hat{c}_1, \dots, \hat{c}_Z\} = \{[\hat{\theta}_1, \hat{\varphi}_1], \dots, [\hat{\theta}_Z, \hat{\varphi}_Z]\}$ , and the training set  $P = \{\hat{p}_1, \dots, \hat{p}_Q\} = \{[\hat{\theta}_{tr,1}, \hat{\varphi}_{tr,1}], \dots, [\hat{\theta}_{tr,Q}, \hat{\varphi}_{tr,Q}]\}$ , with  $Q \gg Z$ , whose elements are randomly distributed. A certain region  $R_i$ ,  $i = 1, \dots, Z$  is associated to each element of  $\hat{C}$ .
- 2) For  $j = 1, \dots, Q$ , assign  $\hat{p}_j$  to the region  $R_i$  by using the rule

$$p_j \in R_i \text{ if } d(\hat{p}_j, \hat{c}_i) < d(\hat{p}_j, \hat{c}_n), \forall n \neq i. \quad (15)$$

- 3) For each region  $R_i$ , compute a new codebook element as follows:

$$\hat{c}_i = \frac{1}{N_{R_i}} \sum_{m \in R_i} m \quad (16)$$

where  $N_{R_i}$  is the cardinality of  $R_i$ .

- 4) Compute the average distorsion as follows:

$$D = \frac{\sum_{i=1}^Z \sum_{m \in R_i} d(m, \hat{c}_i)}{Q} \quad (17)$$

- 5) Go back to step 1) by using the codebook  $\hat{C}$  found in 3). Repeat the previous steps for a certain number of iterations. The final codebook will be the one minimizing the distorsion metric defined in Eq.(17).

Once the codebook  $\hat{C}$  is defined, it can be easily mapped to the equivalent codebook  $\tilde{C} = \{\tilde{c}_1, \dots, \tilde{c}_Z\} = \{\mathbf{V}(\hat{\theta}_1, \hat{\varphi}_1), \dots, \mathbf{V}(\hat{\theta}_Z, \hat{\varphi}_Z)\}$  by applying Eq.(13). The receiver must select the proper element depending on some criterion related to the estimated channel response. In this study, we propose the following two criteria:

- *Maximum SNR*. Select

$$\tilde{c}_s = \arg \max_{\tilde{c}_i \in \tilde{C}} |\mathbf{H}[k] \tilde{c}_i|. \quad (18)$$

where  $|\cdot|$  denotes the unitary norm. Basically, this criterion selects the codebook element that leads to high received signal power in subcarrier  $k$ .

- *Minimum distance*. Select

$$\tilde{c}_s = \arg \min_{\tilde{c}_i \in \tilde{C}} d(\tilde{c}_i, \mathbf{v}[k]) \quad (19)$$

where  $v[k] = [\theta[k], \varphi[k]]$  is derived from the SVD of  $\mathbf{H}[k]$ . This criterion selects the closest element of the codebook to the matrix  $\mathbf{V}[k]$  by using the distance metric defined in Eq.(14).

Once the codebook element is selected, its index is fed back to the transmitter by using  $\log_2 Z$  bits of signaling. Since it is impractical sending a feedback message for each subcarrier, the selection of the codebook element is generally done over a channel averaged in the complex domain over  $N_{sub}$  subcarriers, i.e.,  $\mathbf{H}_{av} = (1/N_{sub}) \cdot \sum_{k=1}^{N_{sub}} \mathbf{H}[k]$ .

**D. Blind precoding**

So far, we have assumed that the precoding matrix is available at the transmitter through a signaling message. This is the only feasible solution in Frequency Division Duplexing (FDD) mode, where transmitter and receiver are operating over different bands. However, in Time Division Duplexing (TDD) mode, where the UE and the BS are transmitting over the same frequencies in different time instants, it would be possible performing the precoding without any feedback from the BS. Both UE and BS could in fact derive the precoding matrix from the channel estimated in a previous received data frame. This idea is explained in details in the follows:

- At time instant  $t_{\alpha_0}$ , the UE receives a data frame and computes  $\mathbf{F}_{t_{\alpha_0}}$  from the estimated  $\mathbf{H}_{t_{\alpha_0}}$ . It uses  $\mathbf{F}_{t_{\alpha_0}}$  to precode the data streams, which are sent at time instant  $t_{\alpha_1} = t_{\alpha_0} + \Delta t$ .
- The BS receives the data frame and computes  $\mathbf{F}_{t_{\alpha_1}}$  from the estimated  $\mathbf{H}_{t_{\alpha_1}}$ . In this case, the MMSE detector can be written as follows:

$$\mathbf{Q}_{t_{\alpha_1}}[k] = (\mathbf{F}_{t_{\alpha_1}}[k]^H \mathbf{H}_{t_{\alpha_1}}[k]^H \mathbf{H}_{t_{\alpha_1}}[k] \mathbf{F}_{t_{\alpha_1}}[k] + \mathbf{R}_{ww} \mathbf{R}_{xx}^{-1})^{-1} \cdot \mathbf{F}_{t_{\alpha_1}}[k]^H \mathbf{H}_{t_{\alpha_1}}[k]^H \quad (20)$$

The difference with (12) is that here the precoding matrix computed at the base station is updated with respect to the one used at the UE. In the following, we will refer to this solution as *blind* precoding. Intuitively, this approach can be considered for a slow time-variant channel, where  $\mathbf{F}_{t_{\alpha_1}} \approx \mathbf{F}_{t_{\alpha_0}}$ . Note that if a weighted power allocation among the antennas is applied, the search of the optimal power vector has to be performed on both the UE and the BS for the computation of  $\mathbf{F}_{t_{\alpha_0}}$  and  $\mathbf{F}_{t_{\alpha_1}}$ , respectively.

**IV. PERFORMANCE EVALUATION**

In order to evaluate the performance of the precoded SU MIMO schemes for both OFDM and SC-FDM, 10 MHz LTE configuration parameters [17] are taken as a reference to run Monte Carlo simulations. All the simulation parameters are gathered in Table I. Realistic channel estimation based on robust Wiener filtering [18] is assumed. QPSK modulation has been considered for pilot symbols, which are transmitted in the first and fifth OFDM/SC-FDM symbol within a slot with an even

TABLE I  
SIMULATION PARAMETERS

Carrier frequency	2 GHz
Sampling frequency	15.36 MHz
Subcarrier spacing	15 KHz
FFT size	1024
Used subcarriers	600
CP length	5.2 <sup>a</sup> /4.68 <sup>b</sup> $\mu s$
Slot duration	0.5 ms
Symbols per slot	7
MIMO schemes	2x2 SM 2x2 CLTD 2x2 SFC
User speed	3 kmph
MCS settings	QPSK: 1/3, 1/2, 2/3 16QAM: 1/2, 2/3, 4/5 64QAM: 1/2, 2/3, 4/5

<sup>a</sup>First OFDM/SC-FDM symbol in a slot.

<sup>b</sup>2<sup>th</sup> – 7<sup>th</sup> OFDM/SC-FDM symbol in a slot.

frequency-domain spacing of 6, following the structure presented in [19] for downlink transmission. Note that imperfect channel estimation affects both the detection and the channel-aware precoding. An urban micro channel model (SCM-D) [20] is used in the simulations. No relevant differences on the trends of the provided results have been noticed by using other channel models, e.g. suburban macro (SCM-A) and urban macro (SCM-C).

We refer to a 2x2 scheme with uncorrelated antennas and 2 codewords. Results are obtained using Fast Link Adaptation (Fast LA) [21]. This means that the Modulation and Coding Scheme (MCS) for each codeword is selected as the one maximizing the expected throughput given the estimated SNR at the receiver in the previous transmission. This is particularly suitable in a precoded system, since the transmission can benefit by applying different MCSs on the data streams depending on the gain of the related eigenmodes. Whether not differently specified, an UE speed of 3 kmph is assumed. A convenient way to express the time delay is through its normalized Doppler form, which is defined as

$$\Delta t_n = \frac{v}{\lambda} \Delta t \quad (21)$$

where  $v$  is the speed of the UE, and  $\lambda$  is the wavelength of the carrier frequency. Performance are evaluated for both OFDM and SC-FDM; with the aim of clarity, only OFDM results are plotted in the case of not relevant differences with SC-FDM.

In Fig.2(a), performance of the precoding with unquantized feedback is presented for OFDM in terms of spectral efficiency. For the *no* precoding case, we mean traditional open loop SM system, i.e.,  $\mathbf{F} = \sqrt{\mathbf{R}_{xx}} \mathbf{I}_{N_T}$ . A 5 ms delay is assumed between the precoding matrix computation in the receiver and its application in the transmission: this corresponds to a normalized Doppler delay of about  $27.77 \times 10^{-3}$ . Note that the performance of precoding

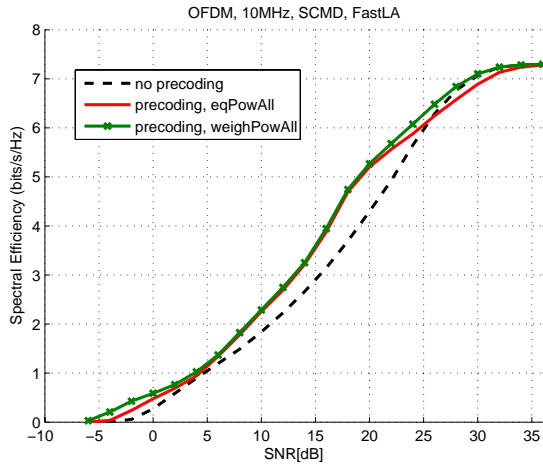

(a)

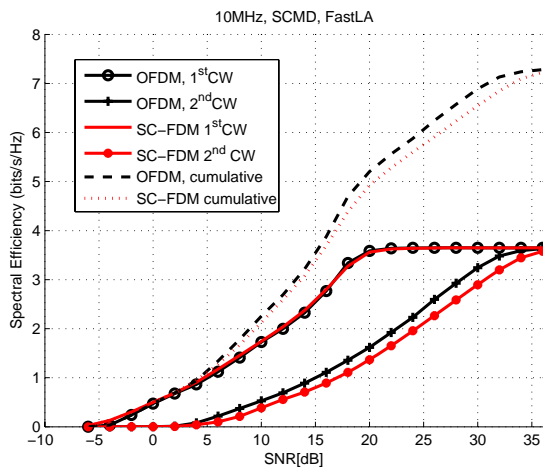

(b)

Fig. 2. Precoding with unquantized feedback,  $\Delta t_n = 27.77 \times 10^{-3}$ : (a) cumulative curve and (b) behaviour of each CW

with unquantized feedback can be considered as an upper bound for the more feasible case of precoding with limited feedback. It can be noticed that precoding with equal power allocation (eqPowAll) leads to a consistent gain in the medium SNR region, but turns into a small loss for high SNRs. Weighted power allocation (weighPowAll) allows to compensate for this loss. Nevertheless, it leads to some performance improvement only in low and high SNR regions. This is because with fast LA different MCSs can be selected to cope with the equivalent channel gains, thus reducing the benefits of applying different power on each stream.

The losses of precoding with equal power allocation in the high SNR region are due to the finite MCS set and can be explained by looking at the fast LA curve of each codeword in Fig.2(b), where also SC-FDM results have been added. The first codeword (1<sup>st</sup> CW), which is transmitted on the strongest eigenmode, tends to dominate the sum throughput performance. However, once the highest order MCS (i.e., 16QAM 4/5) reaches its upper spectral efficiency value, the overall performance

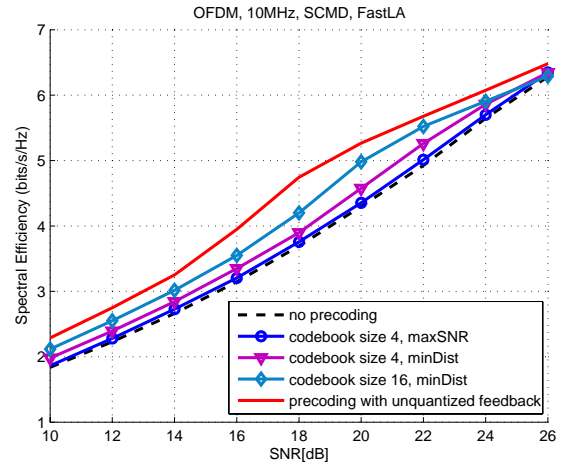

(a)

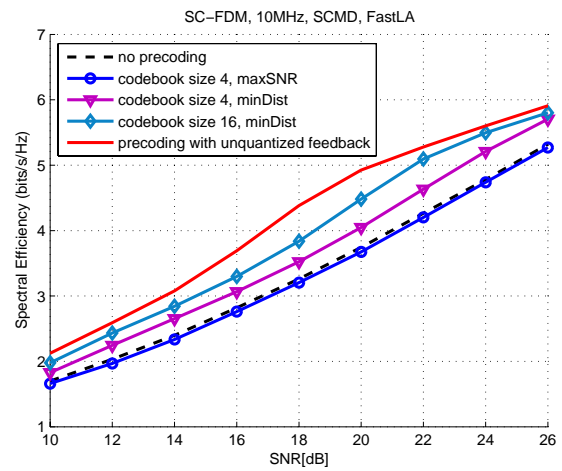

(b)

Fig. 3. Limited feedback precoding for: (a) OFDM; and (b) SC-FDM,  $\Delta t_n = 27.77 \times 10^{-3}$

is dominated by the second codeword (2<sup>nd</sup> CW), which is associated to the weakest equivalent SISO channel. This leads to a decrease of the slope of the cumulative throughput curve, and consequently to a loss in high SNR region with respect to no precoding transmission. Weighted power allocation benefits by applying a higher power to the weakest eigenmode; its gain in low SNR region is instead obtained by applying higher power to the strongest stream, since the throughput associated to the lowest order MCS (i.e. QPSK 1/3) of the weakest stream is still null. Note that for SC-FDM the 1<sup>st</sup> CW has about the same performance as with OFDM. This is because the noise enhancement in SC-FDM is negligible when the equivalent channel gain is very high. However, the noise enhancement increases on the weakest eigenmode, which is associated to the 2<sup>nd</sup> CW, leading to poorer performance than OFDM. As a consequence, the overall spectral efficiency is lower than OFDM.

In Fig.3, the performance of the limited feedback precoding is shown for both OFDM and SC-FDM in a limited SNR range, in order to better highlight the relative



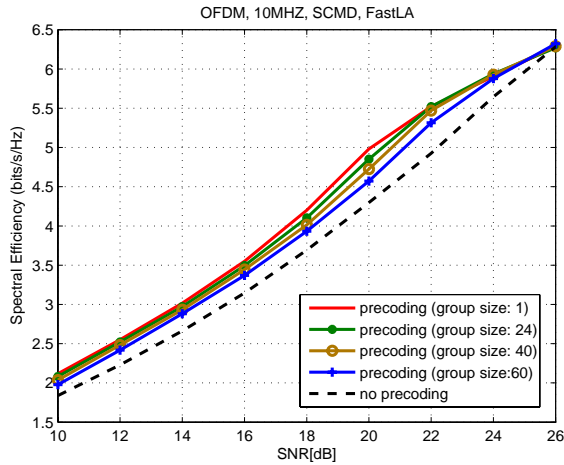

Fig. 4. Limited feedback precoding (codebook size 16): subcarrier grouping effect.

gains among the different solutions. Codebooks of 4 and 16 elements (and therefore requiring respectively 2 and 4 bits of feedback per subcarrier) are generated using the Lloyd Algorithm, and the two different criteria for the selection of the codebook elements are evaluated. Precoding with unquantized feedback is also included for the purpose of comparison. For OFDM, the criterion based on the minimum distance (minDist) with respect to the  $\mathbf{V}$  matrix leads to higher performance gain, up to 2 dB for a codebook of 16 elements. For SC-FDM, the SNR maximization (maxSNR) criterion is even disruptive. This is because, for SC-FDM the power per subcarrier does not match with the power per data symbol, since each symbol is spread over the whole bandwidth. Therefore, the minimum distance criterion performs much better, leading to a gain up to 3 dB with respect to no precoding transmission.

As mentioned in section III, it is unpractical to send a feedback message for each subcarrier, and therefore the selection of the precoding matrix should be made on a frequency averaged channel. In Fig.4, the effect of the subcarrier grouping on the performance gain is shown for OFDM. We consider grouping sizes of 24, 48 and 60 subcarriers, corresponding to 2, 4 and 6 Physical Resource Blocks (PRBs) in the LTE terminology [1]. Note that the performance degradation is small up to a group size of 48 subcarriers; furthermore, a group size of 60 still allows to get about 1 dB of gain over no precoding transmission. This is due to the wide coherence bandwidth of the SCMD channel (around 1 Mhz) [20].

Fig.5 shows the impact of the UE speed on the precoding performance. Further speeds of 10 kmph and 15 kmph are considered; for the same 5 ms delay between precoding matrix computation and its application in the transmitter, this corresponds to a normalized delay of about  $92.59 \times 10^{-3}$  and  $138.88 \times 10^{-3}$ , respectively. For 10 Kmph, precoding still leads to a gain of almost 2 dB, which is considerably reduced for 15 Kmph.

The performance of blind precoding is shown in Fig.6

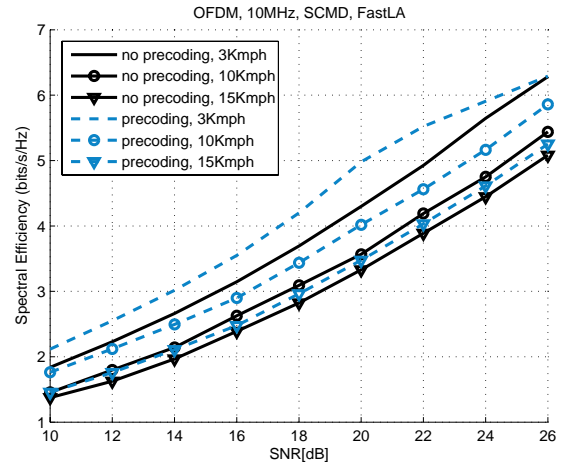

Fig. 5. Impact of the UE speed.

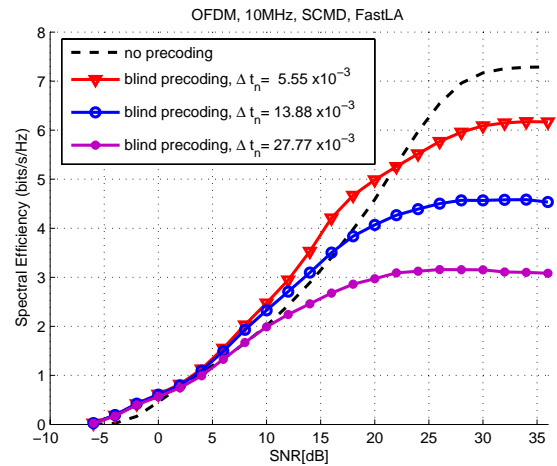

Fig. 6. Blind precoding for different normalized delays.

for different normalized delays. Unfortunately, precoding allows to get a gain only for very short delays between the SVD computation and the transmission over channel, and furthermore only in the low-medium SNR region. A  $27.77 \times 10^{-3}$  normalized delay is already sufficient to completely disrupt the performance.

This result could appear contra-intuitive: performance was expected to improve since the receiver is deriving the precoding matrix from the current channel state. However, in this case different matrices are used in the transmitter and the receiver, respectively, for the precoding and the MMSE detection. It has been shown that the time correlation between the columns of the  $\mathbf{V}$  matrix drops much faster than the correlation between the elements of the channel matrix [22]; this means that, even though after a certain delay the elements of the  $\mathbf{H}$  matrix are still closely related, the corresponding  $\mathbf{V}$  matrices obtained by SVD of  $\mathbf{H}$  could be substantially different. As a consequence, the MMSE detector cannot work properly. Comparing this result with the previous ones at the same normalized delay, we can claim that the impact of the delay is not critical as long as the same matrix is used at both

transmitter and receiver. However, it leads to a consistent degradation if the precoding matrix is re-computed at the receiver based on the current channel estimate. Given its high sensitivity to the delay, blind precoding seems therefore too risky for a practical implementation.

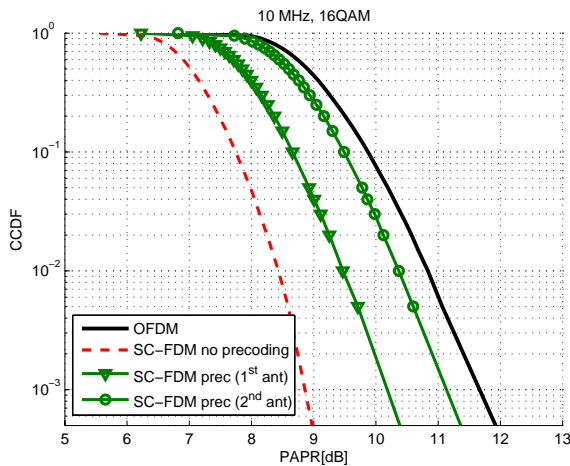

Fig. 7. PAPR performance of precoded signals.

Finally, some considerations on the nature of the precoded signals must be done. Since the precoding operation in frequency-domain is equivalent to a convolution and summation of the data symbols in the time-domain, the PAPR of the transmitted signals could be affected. In Fig. 7, the Cumulative Complementary Distribution Function (CCDF) of the PAPR is plotted for both OFDM and SC-FDM, assuming 16QAM. For OFDM, only the no precoding case has been plotted, since this modulation seems not to be affected by the precoding. SC-FDM curves have been obtained considering limited feedback precoding for SM, with a codebook of 16 elements and a subcarrier grouping of size 48. It can be noticed that the increase of the PAPR for SC-FDM is different on each antenna. In particular, on the second antenna the gain of SC-FDM over OFDM is reduced to around 0.5 dB. This can be explained by looking at the precoding matrix in Eq.(13): the frequency samples transmitted by the first antenna are only weighted by real factors, while the ones transmitted by the second antenna are also phase shifted. Phase shifting in the frequency-domain is certainly more critical for the PAPR increase.

## V. CONCLUSIONS AND FUTURE WORK

In this paper, several MIMO precoding techniques are investigated for both OFDM and SC-FDM, in the case of SM transmission. We consider the specific case of LTE-A uplink, evaluating real degradation factors like delay, speed and subcarrier grouping. In the case of limited feedback, a codebook generation method based on the known Lloyd Algorithm is proposed in combination with two criteria for selecting the matrices to be indexed. Simulation results show a gain of approximately 3 dB over no precoding transmission, for a codebook size of 16

elements, and 1 dB degradation with respect to the upper bound of unquantized feedback precoding. Furthermore, in the studied scenario it is possible to reduce the feedback overhead by grouping the subcarriers without noticeable performance degradation up to 48-subcarrier group (4 PRBs). Our results show that blind precoding, where both UE and BS compute the precoding matrix independently taking advantage of the reciprocity of the TDD channel, is extremely sensitive to the delay, and therefore not recommendable for a real system implementation. Finally, precoding operation yields a degradation in terms of PAPR for the SC-FDM signal up to 2 dB; however, a 0.5 dB gain with respect to OFDM is still preserved.

As a future work, the impact of advanced non-linear receivers like turbo equalizers will be evaluated jointly with precoding. It is expected that SC-FDM will fully overcome the performance gap with OFDM, given the capability of the turbo receivers to reduce its noise enhancement.

## REFERENCES

- [1] "LTE Physical Layer - General Description (Release 8)," 3rd Generation Partnership Project, Tech. Rep. TS 36201, V8.1.0, Nov. 2007.
- [2] L. Hanzo, M. Munster, B. Choi, and T. Keller, *OFDM and MC-CDMA for Broadband MultiUser Communications, WLANs and Broadcasting*. John Wiley - IEEE Press, 2003.
- [3] B. Priyanto, H. Codina, S. Rene, T. Sorensen, and P. Mogensen, "Initial performance evaluation of DFT-spread OFDM based SC-FDMA for UTRA LTE uplink," *IEEE 65th Vehicular Technology Conference, VTC2007-Spring*, pp. 3175-3179, April 2007.
- [4] G. Berardinelli, B. E. Priyanto, T. B. Sørensen, and P. Mogensen, "Improving SC-FDMA performance by turbo equalization in UTRA LTE uplink," *IEEE Vehicular Technology Conference*, pp. 2557-2561, May 2008.
- [5] "Standard for local and metropolitan area networks. part 16: Air interface for fixed and mobile broadband wireless access systems," IEEE Std. 802.16e-2005, Tech. Rep.
- [6] "Capacity of multi-antenna gaussian channels," ATT Bell Labs, Tech. Rep. Technical Memorandum, 1995.
- [7] P. Sampath, H. Stoica and A. Paulraj, "Generalized linear precoder and decoder design for mimo channels using the weighted mmse criterion," *IEEE Transaction on Communications*, vol. 49, no. 12, pp. 2198-2206, Dec. 2001.
- [8] A. Scaglione, P. Stoica, S. Barbarossa, G. Giannakis, and H. Sampath, "Optimal designs for space-time linear precoders and decoders," *IEEE Transaction on Signal Processing*, vol. 5, no. 5, pp. 1051-1064, May 2002.
- [9] D. Love and R. Heath, "Limited feedback unitary precoding for spatial multiplexing systems," *IEEE Transaction on Information Theory*, vol. 51, no. 8, pp. 2967-2976, Aug. 2005.
- [10] S. Zhou and B. Li, "BER criterion and codebook construction for finite-rate precoded spatial multiplexing with linear receivers," *IEEE Transaction on Signal Processing*, vol. 54, no. 5, pp. 1653-1665, May 2006.
- [11] A. Gersho and R. Gray, *Vector Quantization and Signal Compression*. Norwell, MA: Kluwer Academic, 1992.
- [12] D. Falconer, S. Ariyavisitakul, A. Benyamin-Seeyar, and B. Eidson, "Frequency domain equalization for single-carrier broadband wireless systems," *IEEE Communications Magazine*, vol. 40, no. 4, pp. 58-66, Apr 2002.
- [13] G. Golub and C. Loan, *Matrix Computation (3<sup>rd</sup> ed.)*. Johns Hopkins University Press, Baltimore, MD, USA, 1996.
- [14] H. Maahtanen, O. Tirkkonen, and K. Hugl, "Orthogonalizing transmission in MIMO with linear receiver and finite MCS set," *IEEE Wireless Communications and Networking Conference*, pp. 522-527, Apr. 2008.
- [15] S. Tingting, Z. Shidong, and Y. Yao, "Capacity of single carrier systems with frequency-domain equalization," *Proceedings of the IEEE 6th Circuits and Systems Symposium on Emerging Technologies: Frontiers of Mobile and Wireless Communication*, vol. 2.



- [16] K. Cho, D. Yoon, W. Jeong, and M. Kavehrad, "BER analysis of arbitrary rectangular QAM," *Conference Record of the Thirty-Fifth Asilomar Conference on Signals, Systems and Computers*, vol. 2, Nov. 2001.
- [17] "Evolved Universal Terrestrial Radio Access (E-UTRA); Physical Channels and Modulation," 3rd Generation Partnership Project, Tech. Rep. TS 36.211, V8.1.0, 2007.
- [18] O. Edfors, M. Sandell, J. van de Beek, and S. Wilson, "OFDM channel estimation by singular value decomposition," *IEEE Transactions on Communications*, vol. 46, no. 7, pp. 931–939, July 1998.
- [19] "Evolved Universal Terrestrial Radio Access (E-UTRA); Multiplexing and channel coding," 3rd Generation Partnership Project, Tech. Rep. TS 36.212, V8.1.0, 2007.
- [20] "Physical layer aspects for evolved Universal Terrestrial Radio Access (UTRA)," 3rd Generation Partnership Project, Tech. Rep. TR 25.814, V7.1.0, 2006.
- [21] A. Krishnamoorthy, Y. Blankenship, P. Sartori, K. Baum, and B. Classon, "Enhanced Link Adaptation methods for wireless multi-carrier systems," *IEEE Vehicular Technology Conference*, pp. 1911–1915, Apr 2007.
- [22] G. Lebrun, J. Gao, and M. Faulkner, "MIMO transmission over a time-varying channel using SVD," *IEEE Transactions on Wireless Communications*, vol. 4, no. 2, pp. 757–764, March 2005.

**Gilberto Berardinelli** received his first and second level laurea degrees in telecommunication engineering, cum laude, from University of L'Aquila, Italy, in 2003 and 2005, respectively. He also received a second level master in techniques and economics of telecommunications in 2006 from the University of Padova, Italy. In 2006 he worked with the Radio Frequency Engineering Department in Vodafone NV, Padova, where he studied the issues related to the coverage of HSDPA services, and also radio propagation in urban and suburban environments. Since 2007 he has been employed as a research assistant in the Radio Access Technology Section of Aalborg University, Denmark, and successively appointed as a Ph.D. student in the same section. His research interests are mostly focused on physical layer design for 4G systems, thus including multiple access schemes, multi-antenna systems and iterative turbo receivers. He collaborates with Nokia-Siemens Networks in the development of solutions for upcoming LTE-A systems.

**Luis Ángel Maestro Ruiz de Temiño** graduated in mobile communications from Miguel Hernández University, Elche, Spain, in July 2007. From September 2007 to January 2009 he has been working as a research assistant in the Electronic Systems Department of Aalborg University, where he collaborated with Nokia-Siemens Networks in the development of solutions for upcoming LTE-A systems. In February 2009, he joined NSN Innovation Center in Madrid where he collaborates in the development of new product solutions for 3.5G systems. His main interests are in OFDM, MIMO, and LTE-related physical layer studies.

**Simone Frattasi** received his Ph.D. in electrical and electronic engineering from Aalborg University in 2007, and his M.Sc. degree cum laude and B.Sc. degree in telecommunications engineering from Tor Vergata University, Rome, Italy, in 2002 and 2001, respectively. From 2002 to 2005 he was employed as a research assistant at Aalborg University, where he worked on two European projects (STRIKE and VeRT) and one industrial project (JADE) in collaboration with the Global Standards & Research Team, Samsung Electronics Co. Ltd., Korea. Since 2005 he has been an assistant professor, where, besides still contributing to the JADE project, he has been leading a Danish-funded project (COMET). In November 2007 he joined the

Radio Access Technology Section (RATE), where he was project leader of an industrial project (LA-TDD) in collaboration with Nokia Siemens Networks, Aalborg, Denmark. He is author/co-author of around 50 papers published in journals, magazines, and proceedings of international conferences; book chapters; encyclopedia papers; technical reports; and patent applications. He has served as a reviewer for several journals, magazines and international conferences, and as a Guest Editor for Springer, Wireless Personal Communications Journal; IEEE, Technology & Society Magazine; Wiley, Wireless Communications and Mobile Computing Journal; and Academy Publishers, Journal of Communications. He was the main instructor for two half-day tutorials on wireless location at IEEE PIMRC 07 and IADIS WAC07. He was General Chairman of the First International Workshop on Cognitive Radio and Advanced Spectrum Management (CogART 08) and the First International Symposium on Applied Sciences on Biomedical and Communication Technologies (ISABEL 08). In January 2008 he was appointed Chairman of the IEEE GOLD AG Denmark. His research interests mainly include cooperation in wireless networks, link layer techniques, wireless location, quality of service mechanisms, next-generation wireless services and architectures, user perspectives, and sociological dimensions related to the evolution of technology and society.

**Troels B. Sørensen** graduated in 1990 (M.Sc. EE) from Aalborg University, Denmark, and received the Ph.D. degree from the same university in 2002 within the field of wireless communications. From 1991 to 1997 he worked with a Danish telecom operator, developing type approval test methods for the DECT cordless system; in the course of this work he participated in ETSI standardisation. In 1997 he joined the Center for PersonKommunikation (CPK) at Aalborg University where initially his involvement was in propagation modelling for cellular communication systems. Later, his work focussed on system related issues, including cellular system modelling, radio resource management, and specifically distributed antenna systems as the topic of his Ph.D. Most recent and current involvement is in physical layer research for the Long Term Evolution (LTE) and LTE-Advanced, and scalable network deployment related to these systems. Currently, he is Associate Professor with the Radio Access Technology (RATE) section at Aalborg University, Department of Electronic Systems, where he is involved in the supervision of Master and Ph.D. students. Professor Sørensen is a member of IEEE and The Society of Danish Engineers (M.IDA).

**Preben Mogensen** received M.Sc.E.E. and Ph.D. degrees from Aalborg University, Denmark, in 1988 and 1996, respectively. He is currently a professor at Aalborg University, where he is head of the RATE section. He is internationally recognized for his research in mobile communication systems and has more than 130 international publications; he has supervised 14 successfully completed Ph.D. projects. Since 1995 he has also worked part time with Nokia and later on with Nokia Siemens Networks, working on LTE and IMT-Advanced related projects.

**Kari Pajukoski** received his B.S.E.E in 1992. He is currently with Nokia Siemens Networks, Oulu, Finland, where he is working on various topics related to 3G radio standard and its evolution. His current research interests include radio performance and transceiver algorithms.